



Güney Kore Enerji Heyetleri ile B2B Görüşmeleri



Güney Kore'nin Enerji Sektörü Heyetleri İstanbul'a Geliyor

Tarih: 21 Nisan (Öğleden Sonra) & 22 Nisan (Tam Gün)

Yer: Dedeman İstanbul Otel, Gayrettepe

21-22 Nisan 2025 tarihlerinde, Güney Kore'den Enerji Santrali ve Elektrik Ekipmanları Heyeti ile Nükleer Enerji Heyeti, Türkiye'de ilgili sektörlerde faaliyet gösteren firmalar ile iş görüşmeleri gerçekleştirecektir.

Heyetler Hakkında:

Enerji Santrali ve Elektrik Ekipmanları Heyeti

- Organizatör: Korea Electric Engineers Association (KEEA)
- Sponsor: Korea South-East Power Co., Ltd. (KOEN)
- Heyette yer alan firmalar: Elektrik üretim santralleri, enerji iletim & dağıtım ekipmanları, enerji teknolojileri üreticileri ve tedarikçileri (toplam 11 Koreli firma)

Nükleer Enerji Heyeti

- Organizatör: South Gyeongsang Eyaleti & Korea Nuclear Association (KNA)
- Sponsorlar: Korea Hydro & Nuclear Power (KHNP), Doosan Enerbility
- Heyette yer alan firmalar: Nükleer enerji santralleri, mühendislik & altyapı firmaları, nükleer teknoloji üreticileri ve tedarikçileri (toplam 10-12 Koreli firma)

Kimler Katılmalı?

Türkiye'de enerji, elektrik, nükleer enerji, mühendislik ve altyapı sektörlerinde faaliyet gösteren üretici, ticaret, danışmanlık ve diğer hizmet sağlayıcı firmalar için bu etkinlik, Güney Koreli şirketler ile iş birliği fırsatlarını değerlendirme açısından önemli bir platform sunmaktadır.

Başvuru ve Süreç:

- Son Başvuru Tarihi: 31 Mart 2025
- Başvuru Sonuçlarının Açıklanması: 04 Nisan 2025
- B2B Görüşme Takvimlerinin İletilmesi: 7-11 Nisan 2025

İletişim Kişisi: Gökhan Kağan Alanbay

- +90 530 824 5623
- gokhan.alanbay@netzerotekmer.com.tr

Başvuru QR Kodu



Başvuru Linki

<https://gqr.sh/Sxxp>

Organizatör



Sponsor



KOREA EXHIBITOR LIST

2025 Türkiye Delegation

Sponsored By : Korea South-East Power Co., Ltd. (KOEN)

Organized By : Korea Electric Engineers Association (KEEA)

Managed By : LEEBRIDGE

Apr 21(Mon), 2025 ~ Apr 22(Tue), 2025/ Istanbul, Türkiye

E-mail: Leo@leebridge.co.kr / sales@leebridge.co.kr

ywlee@leebridge.co.kr / marketing@leebridge.co.kr

Sponsored By

Korea South-East Power Co., Ltd. (KOEN)

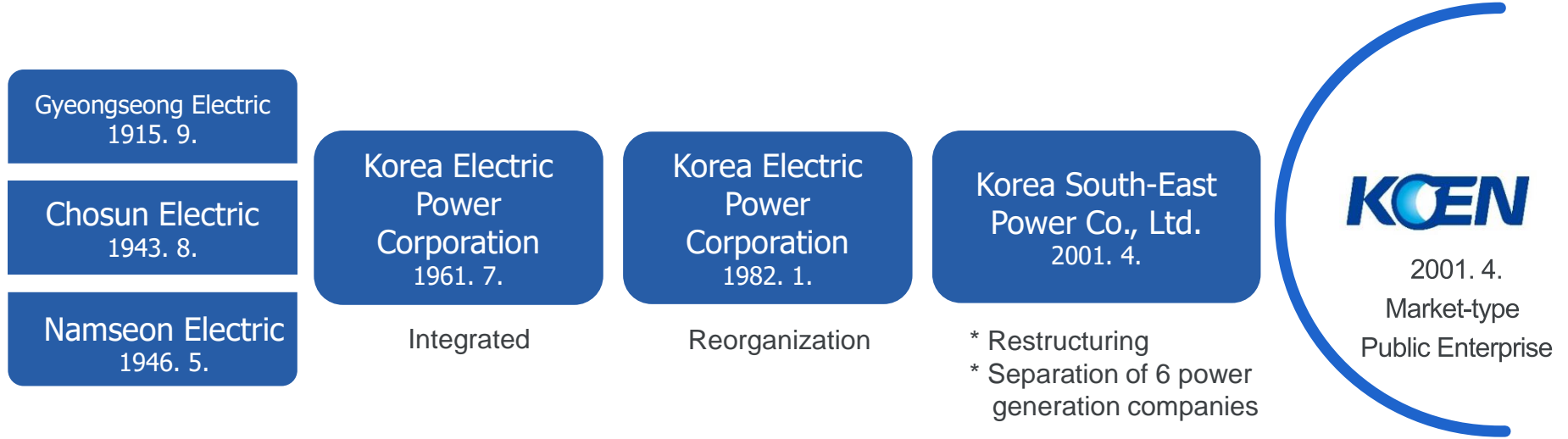

Business Area

1. Power Resources Development
2. Power generation
3. R&D, Construction Management
4. Overseas Project 1~3
5. Investment in Project 1~4
6. Incidental Project 1~5

Employees 2,705

Capacity 10,038.2MW (Occupies 7.3% of Domestic Facility)

Generatio 44,873GWh (Occupies 7.7% of Domestic Power Gene.)

Asset 15 Trillion Won

Sales 9.1 Trillion Won

Sponsored By

Korea South-East Power Co., Ltd. (KOEN)

General

Energy Facilities

Capacity 10,038.2MW

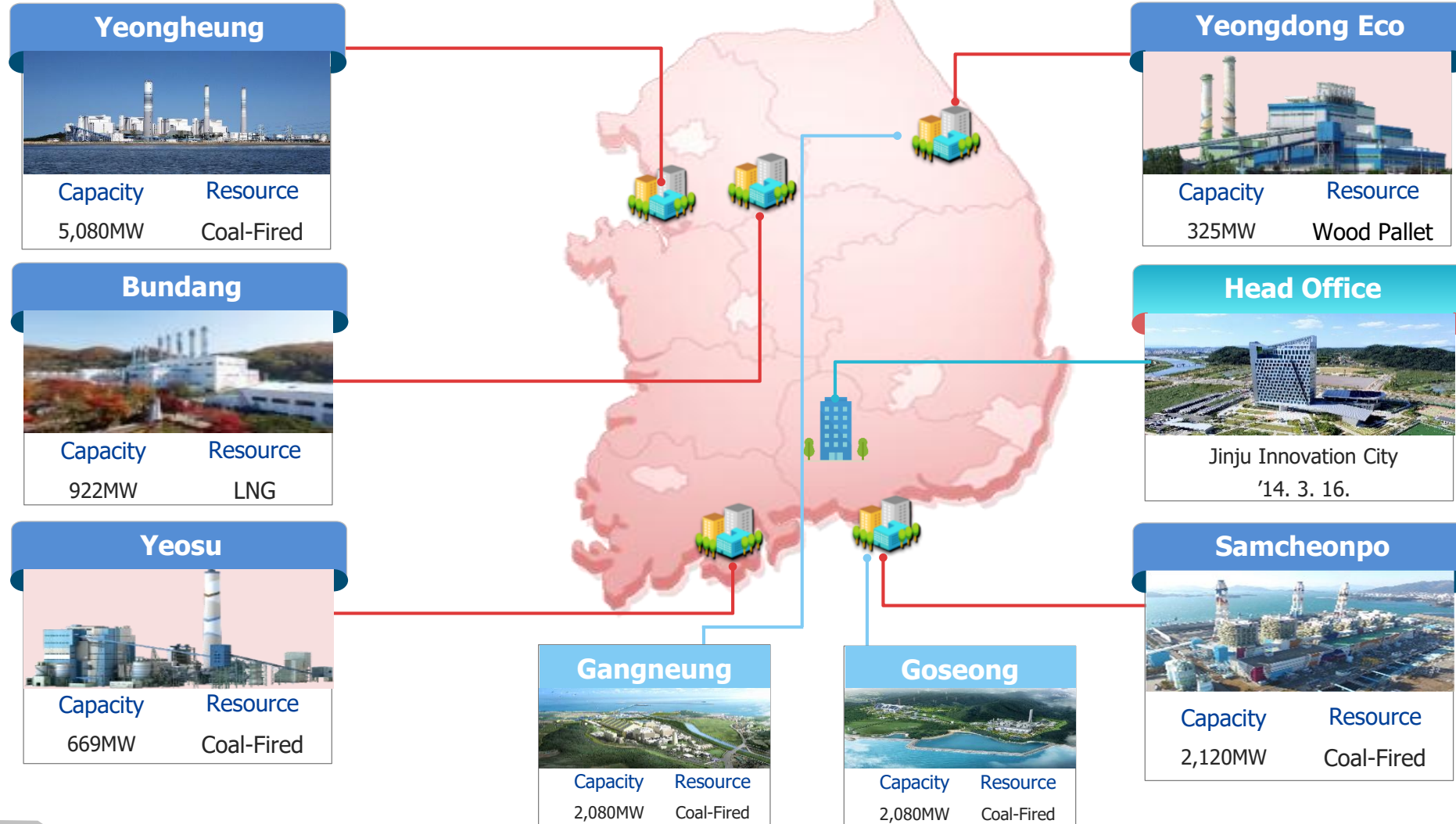

Sponsored By

Korea South-East Power Co., Ltd. (KOEN)

Strategy

Overseas Business



In Operation **Under Construction** **In Progress** **In Progress (Resource)** **Office**

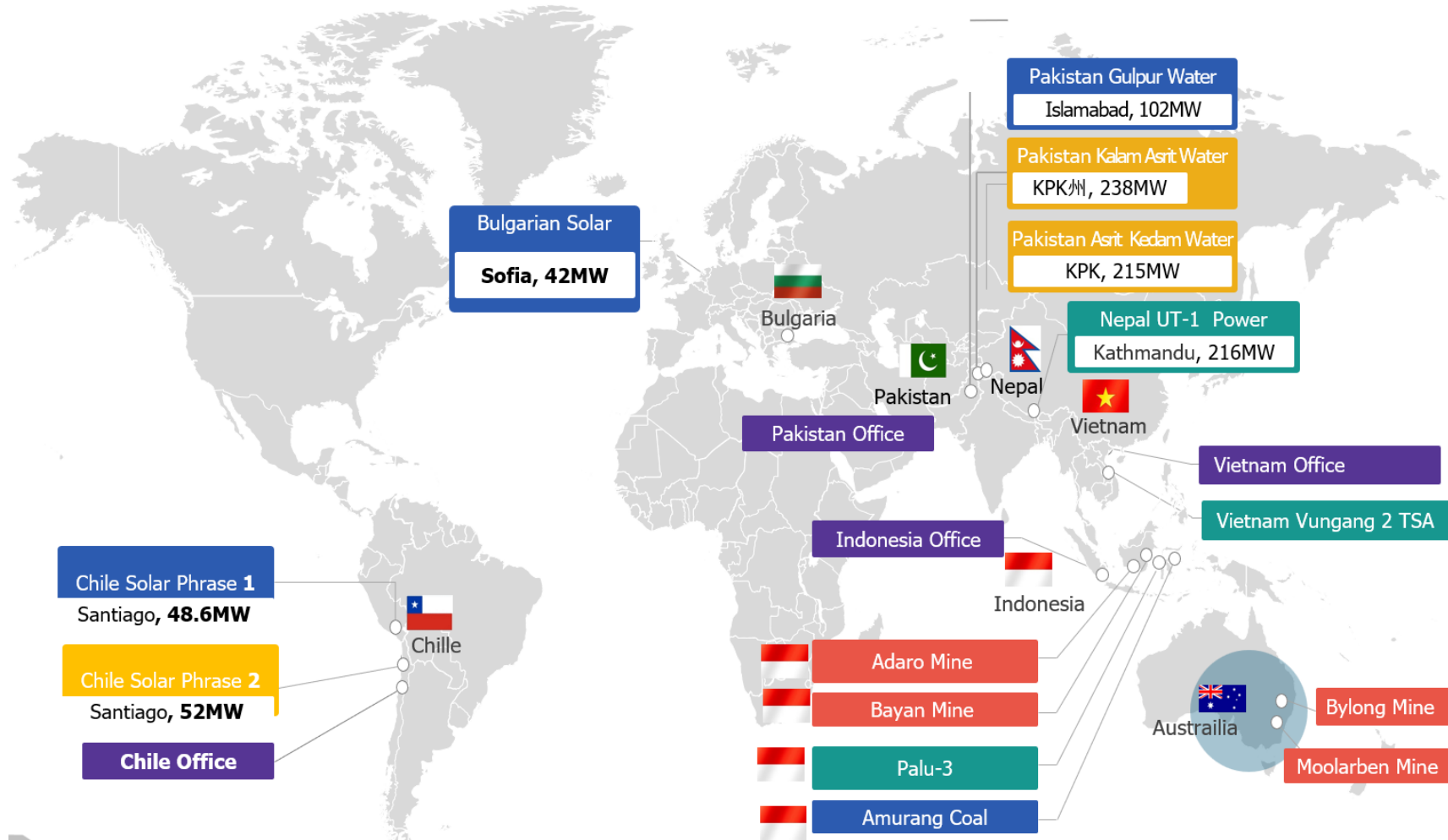

Sponsored By

Korea South-East Power Co., Ltd. (KOEN)

R&D

Support System



Small and medium-sized enterprise technology development project

Business overview

- Collaborate with SMEs to Develop Essential Technologies, New Products, and Localization for Power Plants: Securing Core Technologies and Strengthening SME Technological Competitiveness

Support details

Division	support	Share Ratio		
		Total development cost (₩)	KOEN	SME
Field technology research and development	KOEN	Less than 300 million	75%	25%
		300~700 million	70%	30%
Collaborative research and development with five power generation companies	5 power generation companies	More than 700 million	65%	35%
		Ministry of SMEs and Startups	KOEN	SME
Joint investment technology development	KOEN + Ministry of SMEs and Startups	39.4%	39.4%	21.2%

Support scale - Approximately 30 projects per year



Switzerland International Invention Exhibition 4-crown winner ('23.4)

Organized By

Korea Electric Engineers Association (KEEA)

INTRODUCTION OF THE ASSOCIATION

General status

- Name : Korea Electric Engineers Association
- Address : 2040, Nambusunhwan-ro, Gwanak-gu, Seoul 08805, Rep. Of Korea
- Founded date : Dec. 14, 1963

Purpose

The purpose of the association is to promote the R&D of electric technology, improve the quality of electric facilities, as well as keeping the training, management and welfare programming of electric engineers in order to contribute to the industrial development of Korea

Organized By

Korea Electric Engineers Association (KEEA)

Main Projects

Government entrusted work



Legal basis

Entrusted work

Electricity enterprises act

Acceptance of appointment and discharge report certificate of electric safety manager

Education of safety management for electric safety manager

Acceptance of registration of change report on electric safety management agency

Management of career of electric engineers/
Issue of career handbook and other certificates

Acceptance of supervisor allocation report/Issue of allocation confirmation

Construction supervision report acceptance and issue of a certificate

Electric technology
management act

Education of electric safety managers and supervisors

Actual result management of design and supervision companies

Registration of design supervision business
/Record and management of changes in registration

Mutual-aid project for financing and liability guarantee for damage compensation

Organized By

Korea Electric Engineers Association (KEEA)

Main Projects

Government entrusted work



- **Other services**

- Investigation, study, development, publication promotion and advertising of electric technologies
- Diagnosis of electric facilities, technical support investigation and analysis of accidents
- Promotion of welfare and protection of rights for electric engineers
- Establishment and operation of annex Electric Power Technology Research Institute(EPTRI)
- Operation of electric technology support center
- Operation of electric engineers employment support center
- Publishing of periodicals and online news service related to electrical industry

- **Organization chart**

- Organization : 2 division 4 department 2 institute 1 room, 21 provincial branches
- The number of persons : 150 persons

Summary of Exhibitor

No.	Company	Product	Homepage
1	IAM Co., Ltd.	DTS (Optical fiber Temperature Measurement System - OTMS™), Outdoor fire hydrant automatic display device	www.visit-iam.com
2	KOREA ENGINEERING CO.,LTD	Igniter Exciter, Igniter Cable Lead & Rod, Igniter Spark Plug	www.igkec.com
3	MUHA INC.	DCS I/o Module & Relay Diagnosis Equipment, etc.	www.muha.kr
4	EPiT	Bag Filter (EPiT pleated bag), Electrostatic Precipitator	www.epit.co.kr
5	G-TOPS Co., Ltd	Valves, pumps, actuators, transformers, dust collectors, etc.	www.global-tops.com
6	Jac coupling	coupling	www.jacoup.co.kr
7	ECOPOWERTEC CO., LTD	Fire spread prevention insulation materials, flame spread prevention products, etc.	www.ecopowertec.kr
8	HANDOL PUMPS LIMITED	Industrial centrifugal pump	www.handolpumps.com
9	Jeongwoo Industrial Machine, Co., Ltd.	Industrial Machines (Filter Equipment, Turbine/Generator System), Piping Support	www.jimc.co.kr
10	YPP	Electrical equipment control and monitoring system	www.ypp.co.kr
11	Dongsung ES	Motor power load optimal control device, DST venturi steam trap	www.gesds.com

1. [IAM Co., Ltd.](#) ← Click to link Homepage

- IAM Co., Ltd. is specialized in the new technology to measure temperature using optical fiber cable and using mobile technology for the facility management.
- OTMS (Optical fiber Temperature Measurement System) is a proprietary technology developed based on the same concept as DTS (Distributed Temperature Sensing).
- By detecting scattered light within the optical fiber, OTMS enables simultaneous measurement of thousands of temperature points, allowing precise monitoring with just a single optical fiber strand.
- Product (Service) : Optical fiber Temperature Measurement System

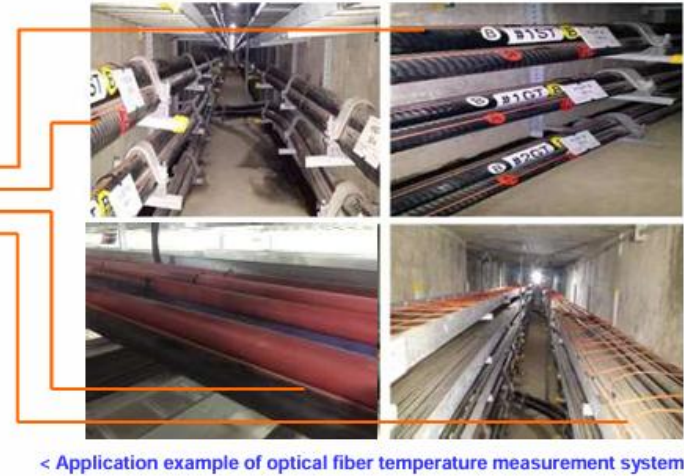

2. Korea Engineering Co., Ltd.

- Korea Engineering designs, engineers, installs, and services best-in-class ignition systems for industrial boilers and gas turbines, supplying to major thermal plants with state-of-the-art products
- The company has expanded its product line to include igniter exciters, igniter spark plugs, and igniter leads, providing high-performance and cost-effective solutions for both domestic and international customers
- Product (Service) :
 - Igniter Exciter
 - Igniter Cable Lead
 - Igniter Spark Plug
 - Igniter Exciter Controller



3. MUHA INC.

- MUHA INC is based on the hardware, firmware, and application software development technology of the control system for power plants and plant industries, we want to become a leader in the era of the 4th industrial revolution by converging IoT and AI technologies.



DCS I/o Module & Relay Diagnosis Equipment



Thermal Stress Monitoring System

- Product (Service) :
 - DCS I/o Module & Relay Diagnosis Equipment
 - Thermal Stress Monitoring System
 - Position Control System / PCS
 - AI Air Quality Improvement System
 - Precision Diagnostics Service
(DCS Power Supply & Module / Relay / TC Sensor)



Position Control System



AI Air Quality Improvement System

4. EPiT Co.,Ltd.

- EPiT Co.,Ltd. is specialized in atmospheric environment fields and we carries out everything from design to construction of electrostatic precipitator and Bag Filter.
- In particular, EPiT Co.,Ltd. developed its own filter bag, which is an internal core part of the filtration dust collector as well as produced and supplied ‘EPiT Pleated filter bag’, which can be expanded 2 to 3 times compared to existing filter(Tubular) bag.
- Product (Service) :
 - Electrostatic Precipitator
 - Bag Filter & EPiT Pleated Filter bag
 - Technical Services



< EPiT pleated bag >

5. G-TOPS

- G-TOPS is a special purpose corporation established jointly by KOEN(korea south-east power co.) a public corporation, and 14 small and medium-sized enterprises associations for shared growth with domestic SMEs and the development of the plant industry.
- G-TOPS is a "Plant Equipment Comprehensive Trading Company" that exports excellent products of small and medium-sized Korean companies to overseas markets
- Product (Service) :
 - VALVE & ACTUATOR
 - FITTING
 - SYSTEM & FACILITIES
 - PUMP
 - AUX. EQUIPMENTS
 - TURBINE COMPONENTS
 - TRANSFOMER/ TRANSFOMER RECTIFIER
 - ETC



5. Jac coupling

- JAC Coupling has supplied and made constant effort to develop high-quality power transmission coupling product to its customers.
- Jac Coupling has been producing various types of high-quality couplings for over 40 years based on its extensive experience.
- Product (Service) :
 - Gear coupling
 - Disk coupling
 - Grid coupling
 - Fluid coupling
 - Rubber coupling
 - Various types of couplings



Gear coupling



Grid coupling



Disc coupling



Wind turbine coupling



Composite coupling



Wire drum coupling



Tire & Rubber coupling

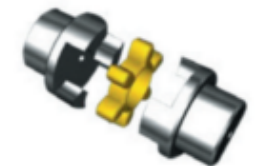

Jaw coupling

7. ECOPOWERTEC

- ECOPOWERTEC is manufacturing company which especially specialized in 4R (Reusable /Resilient /Removable /Resourceful) Insulation Cover . This is an eco-friendly thermal insulation system installed to insulate high temperature equipment in plants.
- Excellent insulation saves energy, and waste is reduced through reuse, enabling resource conservation and economical energy use. It also protects workers from burns, ensuring worker safety.
- Product (Service) :

Insulation materials

- Detachable Thermal Insulation
- Fire Spread Prevention Insulation
- Metal Casing Insulation

Valve

- Swing blind valve
- Scroll blind valve
- Tilting Gate valve

Fire protection products

- Flame Retardant Fabric
- Fire-Resistant Paint
- Fire-Resistant Putty, Fire-Resistant Silicone

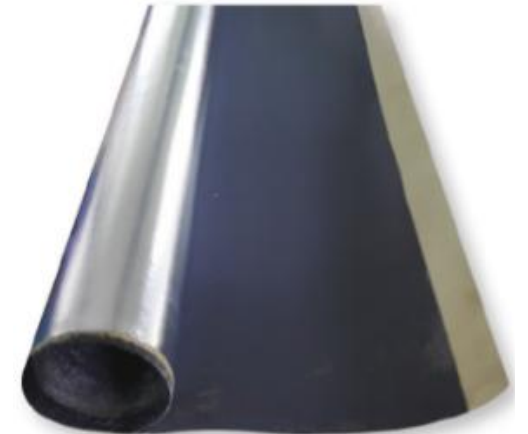
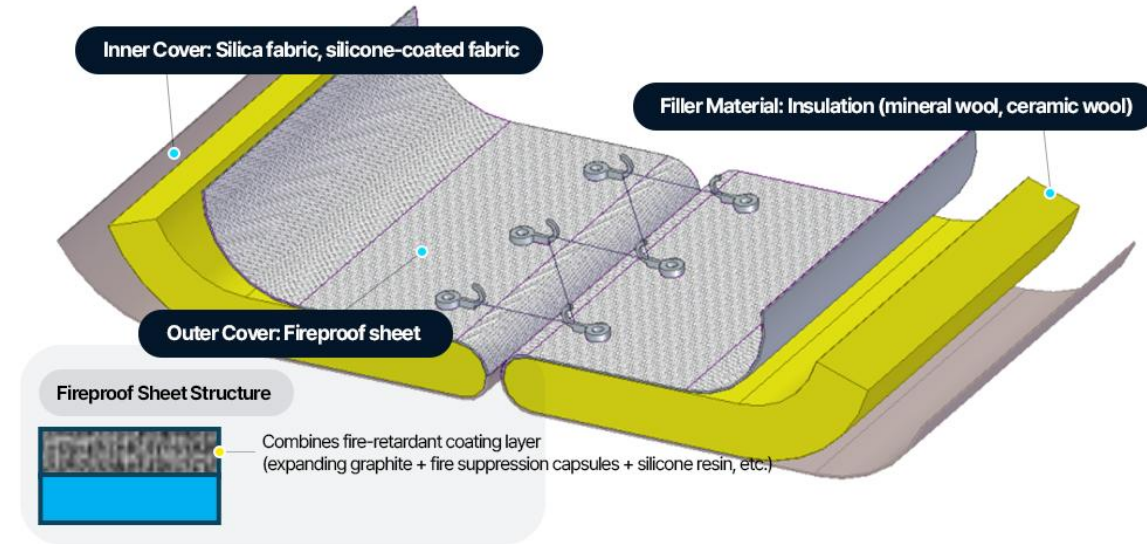

8. HANDOL PUMPS LIMITED

- HANDOL PUMPS LIMITED is a leading manufacturer specializing in API 610 centrifugal pumps.
- Since its establishment in 1993, the company has developed and produced centrifugal pumps for power generation, oil & gas, petrochemical, and other industries.
- With exports to over 30 countries, HANDOL PUMPS is globally recognized for its technical excellence.
- Product (Service) :
 - Axially Split Pumps
 - Double-Casing Pumps
 - Ring section Pumps
 - Two-stage Pumps
 - Single-stage Pumps
 - Magnetic Drive Pumps
 - Vertical Pumps
 - Axial Flow Pumps



Overhung



Between Bearing



Vertically Suspended

9. Jeongwoo Industrial Machine, Co., Ltd.

- Jeongwoo Industrial Machine Co., Ltd. specializes in energy plant equipment and supplies high-quality products to the power generation, gas, oil refinery, and energy industries both domestically and internationally.
- Through continuous technological development and patented innovations, the company strives to deliver superior solutions to its customers..
- Product (Service) :

Industrial Machines

Filter Equipment

- Condenser Tube Cleaning System
- Debris Filter
- Strainer

Turbine/Generator System

- Seal Oil Unit
- Stator Cooling Water Unit
- Lube Oil Unit
- Gland Steam Condenser

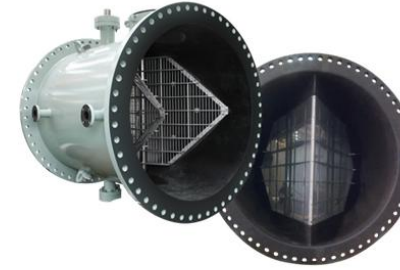

Ball Strainer



Ball Collector



Debris Filter



Seal Oil Unit

Piping Support

Piping Support Equipment

- Spring Hangers & Supports
- Dynamically Loaded Elements
- Structural Attachment Elements
- Connecting Elements
- Pipe Attachment Elements
- Miscellaneous Elements

Cryogenic Piping Supports

- Shoe Type
- Hold Down Type
- Anchor Type

10. YPP

- YPP is a provider of power and energy solutions, specializing in power protection systems, facility diagnostics, and plant control systems.
- The company supplies electrical protection and control systems, substation automation, temperature monitoring, and offers maintenance and consulting services.
- YPP also manufactures digital protection relays, industrial communication devices, UPS, and control panels while offering specialized training in power system protection and control.
- Product (Service) :
 - Power facility protection monitoring and control system
 - Facility diagnosis system
 - Digital protection relay



11. Dongsung ES

- Dongsung ES is an engineering company specializing in energy efficiency that dramatically saves energy by optimally using heat and electric energy, which are the main sources of energy consumption.
- The representative products are the DST Venturi steam trap, which saves steam, which is heat energy, and Optimum Power Control Device for Motor (OPC-M), which saves electricity.
- Product (Service):
 - Optimum Power Control Device for Motor (OPC-M)
 - DST Venturi steam trap



<OPC-M>



<DST Venturi steam trap>

KOREA EXHIBITOR LIST

2025 Türkiye Delegation

Gyeongsangnamdo / Gyeongnam Technopark

Apr 21(Mon), 2025 ~ Apr 22(Tue), 2025
Dedeman İstanbul Hotel İstanbul, Türkiye
E-mail: Leo@leebridge.co.kr / sales@leebridge.co.kr
ywlee@leebridge.co.kr / marketing@leebridge.co.kr

Summary of Exhibitor



No.	Company	Product	Homepage
1	KNA	Korea Nuclear Association for International Cooperation	www.e-kna.org
2	Doosan Enerbility	Core components for turbines, reactors, boilers and power plants	www.doosanenerbility.com
3	SamHong Machinery Co.,Ltd.	Power Plant Parts (Cask, RCS Piping, Tube Sheet, etc)	www.shemc.co.kr
4	KOREA PRECISION ENG Co., Ltd.	Forging Dies Products , Machining Solutions (JIG & FIXTURE, Precision Part Processing)	www.kopico.co.kr
5	Hankook Plantech	Power generation and industrial equipment services	www.hkpt.co.kr
6	WELLSYSMETAL	Coupler	www.wellsysmetal.com
7	SNT Energy Co., Ltd.	Air Cooler, H.R.S.G, Condenser, S.C.R system	www.hisnt.com

1. KNA

- KNA (Korea Nuclear Association for International Cooperation) mainly focuses on promoting and exporting South Korea's nuclear power technologies and services. It supports member companies in networking and collaboration, while also offering market insights and industry reports. KNA plays a key role in strengthening the global presence of South Korean nuclear-related products and services.
- It facilitates the export of nuclear power technologies, offers networking opportunities, and provides resources such as market reports and industry news. It also offers membership benefits for companies in the nuclear sector and hosts international events related to nuclear power.



2. Doosan Enerbility

- Doosan Enerbility is a leading energy solutions provider specializing in power generation, including nuclear, combined-cycle, and renewable energy.
- The company leverages advanced engineering and manufacturing expertise to deliver turbines, reactors, and key components worldwide.
- Doosan Enerbility is also actively involved in the development of Small Modular Reactors (SMRs) and plans to supply key components for them in the future.
- Product (Service) :
 - RPV, Reactor Pressure Vessel
 - Steam Generator
 - Pressurizer
 - Upper & Lower Reactor Internals
 - Reactor Coolant Pump, RCP
 - MMIS, Man-Machine Interface System)

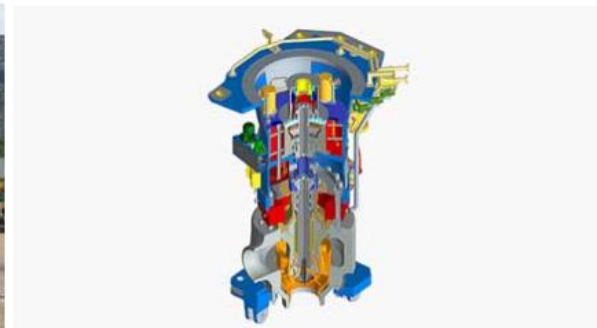

3. SamHong Machinery Co.,Ltd.

- Samhong Machinery specializes in the production of nuclear power plant parts and precision processing of parts, producing a wide range of products from ship engines to nuclear power plant services (maintenance), SMR (small modular reactors), and the International Thermonuclear Experimental Reactor (ITER) based on its long-standing know-how in manufacturing industrial machinery parts.
- A key strength of our company is our ability to handle both fabrication and machining in-house, offering a streamlined solution for complex projects.
- Product (Service) :
 - Marine& Stationary Engine Parts
 - Compressor Part
 - Pump Parts
 - Power Plant Parts
 - Machine Tool, Industrial Machinery Parts & Vacuum Chamber
 - ITER Project



Cask



RCS piping



Tube sheet



Tube sheet

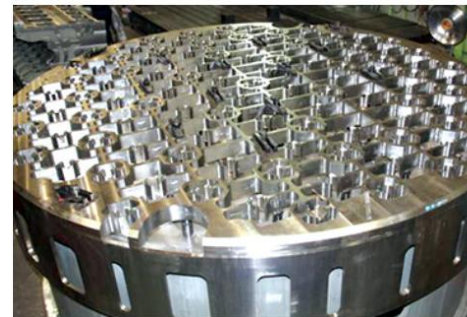

Top plate



Primary lid

4. KOREA PRECISION ENG Co., Ltd

- Since its establishment in 1976 as a company specializing in cold and warm forging dies, Korea Precision ENG Co. has been dedicated to delivering high-quality products through continuous research and development.
- With its accumulated expertise in difficult-to-cut metal processing, the company has expanded its business into various fields, including nuclear power, plant equipment, industrial machine parts, and complex metal forming, always striving to meet customer needs.

- Product (Service) :

- Rotary Joint
- CEDM Nozzle
- 4 Die Fogging

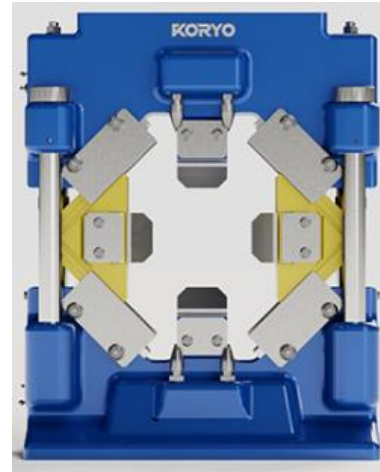

5. Hankook Plantech

- Hankook Plantech specializes in providing engineering solutions for large-scale plant projects, including design, construction, maintenance, and project management
- With a focus on power plants and industrial facilities, the company is known for its technical expertise and commitment to quality.
- Product (Service) :
 - Replacement & Repair of Field Generator
 - Replacement & Maintenance of Turbines
 - Exchanging LP Heater inside the Condenser
 - Special Tool Box
 - Working Stand For the LP-Casing Assembly
 - Container For Transper Of The Turbine Rotor
 - Stand For The Comp Disk Assembly
 - etc



LP Rotor Drawer



LP Lower Casing Drawer



LP Rotor Drawer



Seating the Exist LP Rotor



Seating the Exist LP Lower Casing



Blade Ring Dismantling, Lifting



Blade Ring Assembly & Clearance Check



Blade Ring Assembly & Bolt Tightening

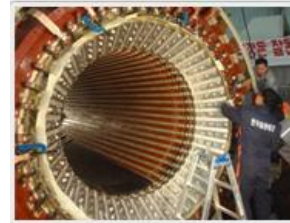

Dismantling of the Generator



Stator Bar Drawer

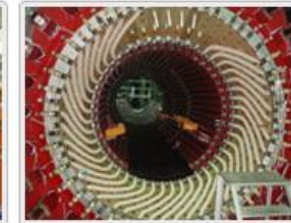

New Stator Bar Insert

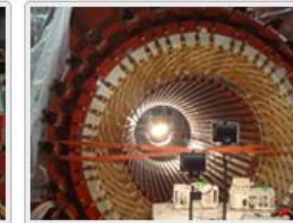

Test



Special Tool Box

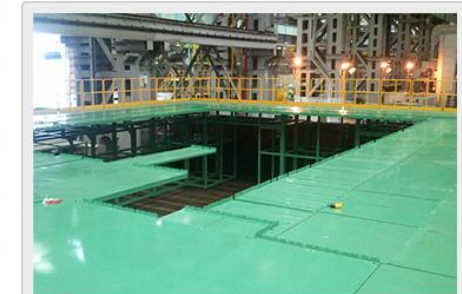

Working Stand For The LP-Casing Assembly

6. WELLSYSMETAL

- As a global leader in steel distribution, exporting and supplying various steel and metal products such as steel pipes, fittings, flanges, forgings, valves, and bolts/nuts, we have newly designed a rebar coupler required for concrete pouring at construction sites after years of dedicated research.
- The "WelSys Coupler" is a newly developed coupler featuring an innovative one-touch locking mechanism that eliminates the drawbacks of conventional couplers while ensuring exceptional stability and outstanding ease of installation.
- Product (Service) :
 - General Type Coupler
 - Reducing Type Coupler
 - Welding Type Coupler
 - Hybrid Type Coupler
 - Form Saver Coupler



7. SNT Energy Co., Ltd.

- SNT Energy is recognized in the global market for its outstanding technological competitiveness in energy plants, including petrochemical refining, gas plants, and power generation facilities.
- SNT Energy has secured core green energy technologies, such as air coolers, heat recovery steam generators (H.R.S.G.), denitrification systems, and nuclear power plants.
- Product (Service) :
 - Air Cooled Heat Exchanger
 - Heat Recovery Steam Generator (H.R.S.G)
 - Surface Condenser
 - S.C.R System



Air Cooled Heat Exchanger



Surface Condenser



Heat Recovery Steam Generator



S.C.R System